

SKIL MASTERS

PROFESSIONAL POWER TOOLS

IMPACT DRILL
6410 (F0156410..)



ORIGINAL INSTRUCTIONS



www.skilmasters.com



1 6410

600
Watt
110 V

EPTA 01/2003
1.9 kg

 n_0
0-3000/min

2-13 mm

0-48000 p/min

13 mm



16 mm

35 mm

4m
RUBBER

110 V

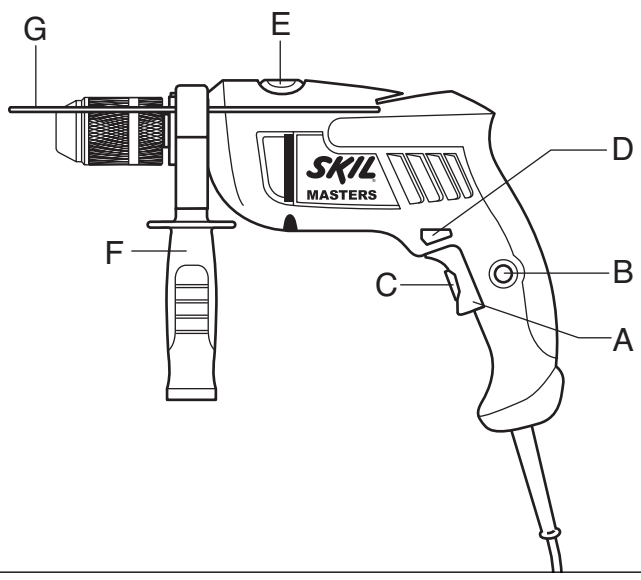
2



3



4



5

1

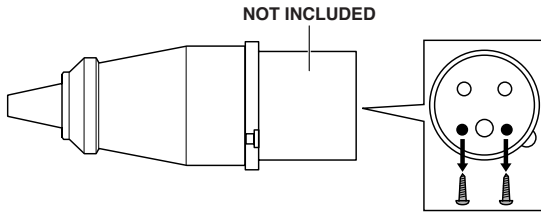

2

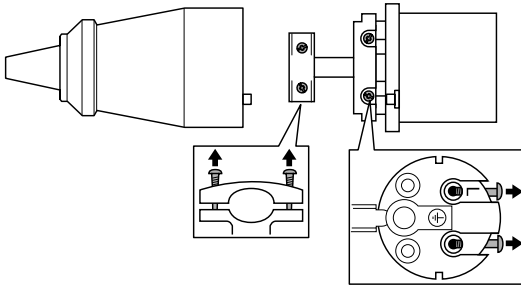

3

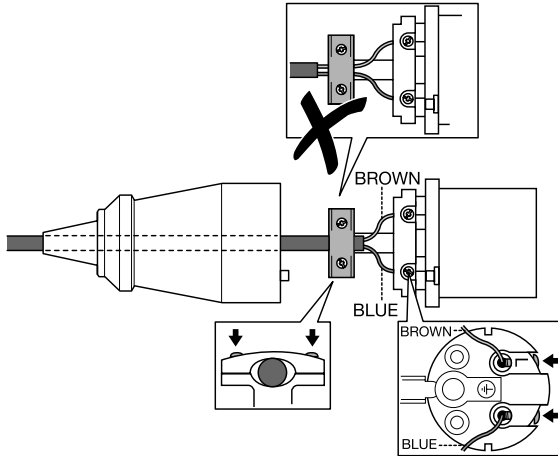

4

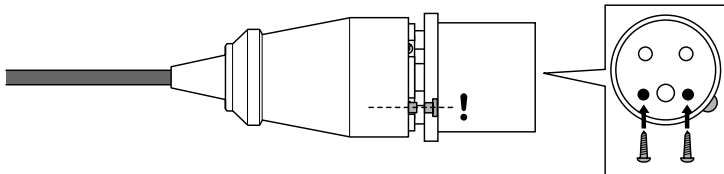

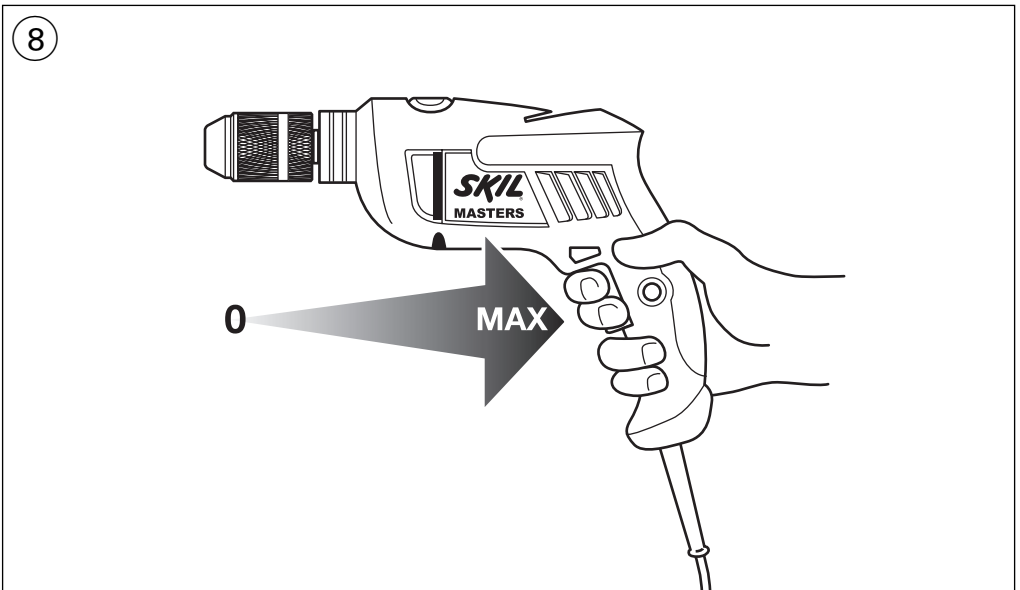
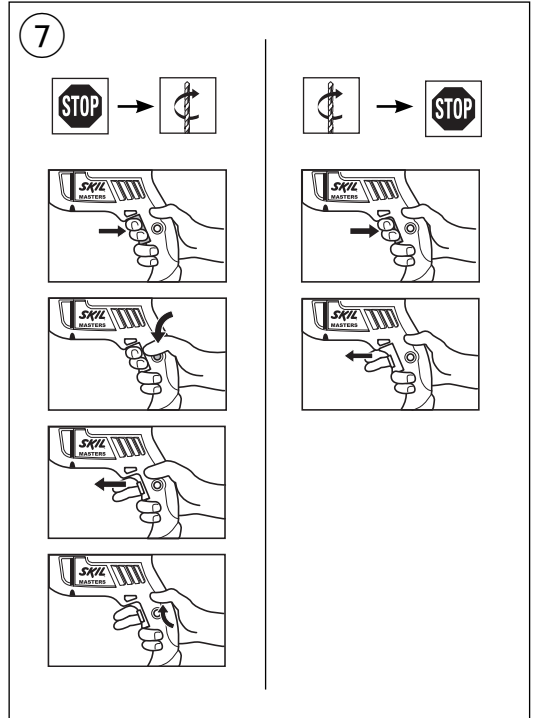
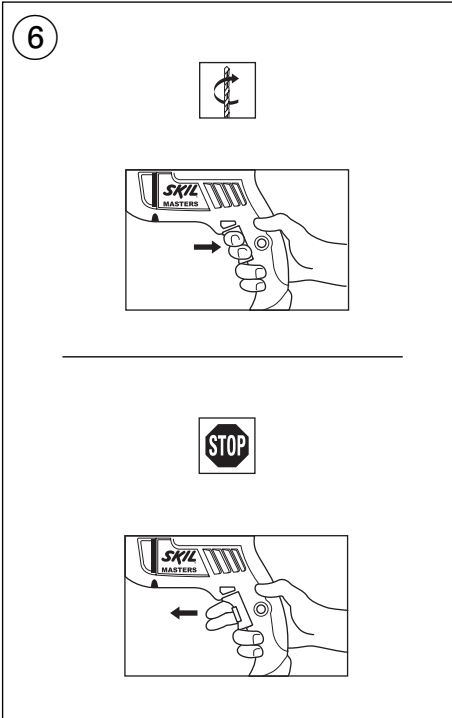

9

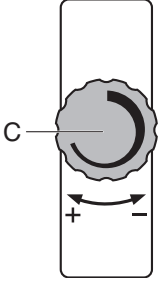

10

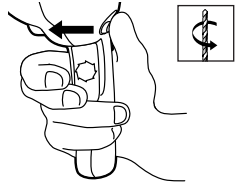
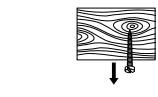
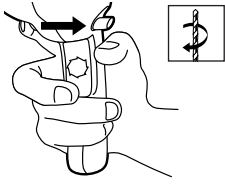
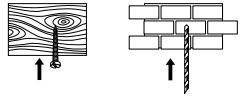

11

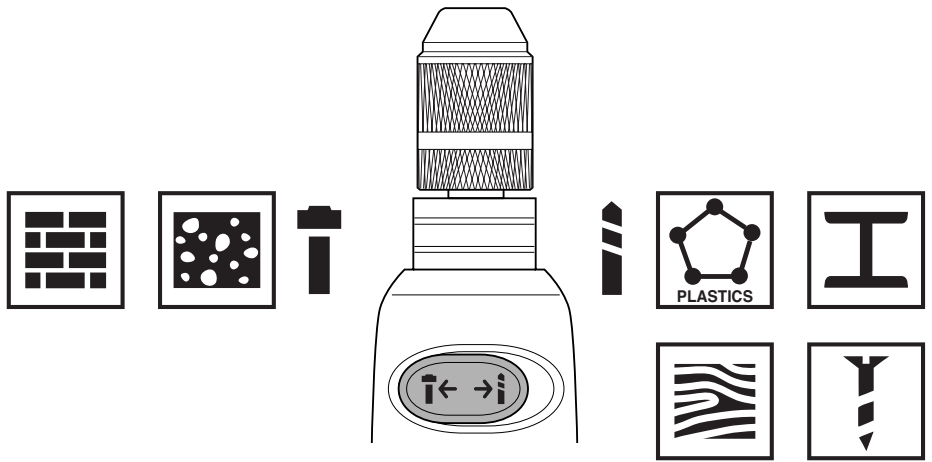

12

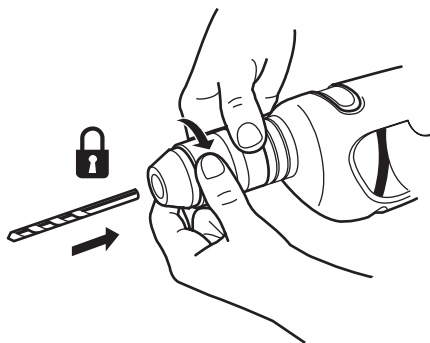
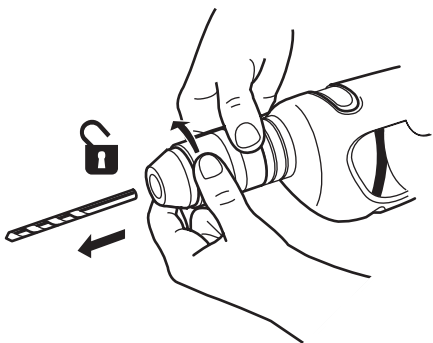

13

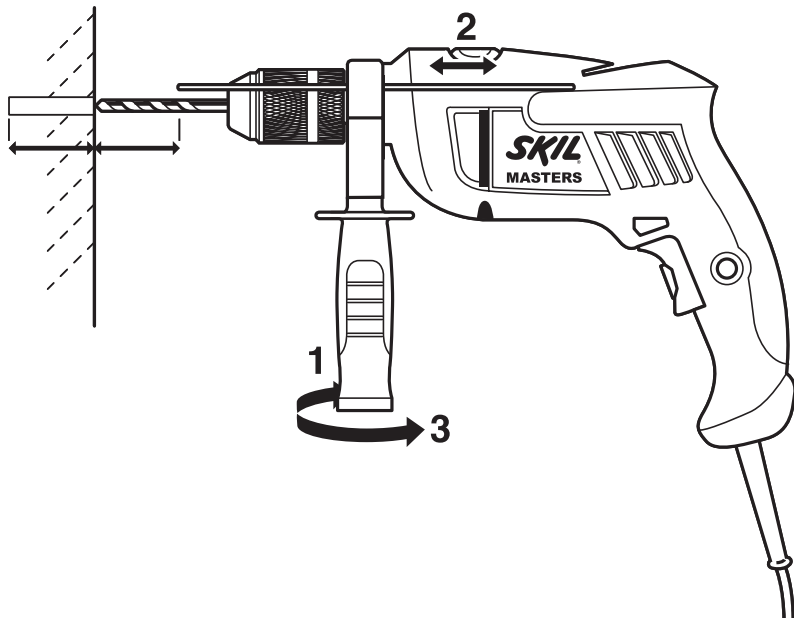

14

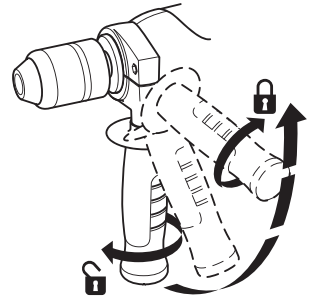
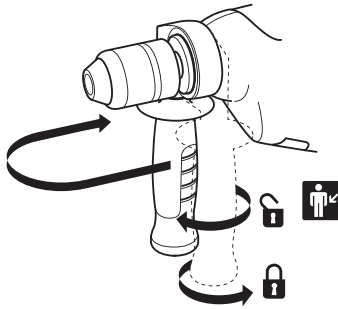
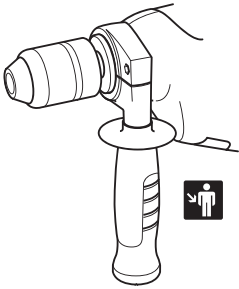
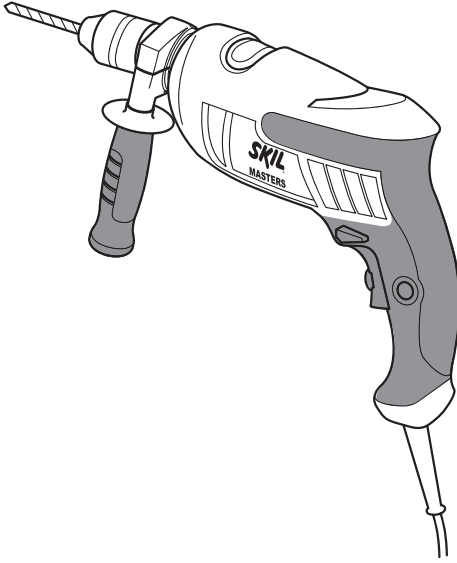

15



Impact drill

6410

INTRODUCTION

- This tool is intended for impact drilling in brick, concrete and stone as well as for drilling in wood, metal, ceramic and plastic; tools with electronic speed control and left/right rotation are also suitable for screwdriving and thread cutting
- Read and save this instruction manual ③

TECHNICAL SPECIFICATIONS ①

TOOL ELEMENTS ②

- A Switch for on/off and speed control
- B Button for switch locking
- C Wheel for maximum speed control
- D Switch for changing direction of rotation
- E Switch for selecting drilling function
- F Auxiliary handle
- G Depth gauge

SAFETY

GENERAL SAFETY INSTRUCTIONS

⚠ WARNING! Read all safety warnings and all instructions. Failure to follow the warnings and instructions may result in electric shock, fire and/or serious injury. **Save all warnings and instructions for future reference.** The term "power tool" in the warnings refers to your mains-operated (corded) power tool or battery-operated (cordless) power tool.

1) WORK AREA SAFETY

- a) **Keep work area clean and well lit.**
Cluttered or dark areas invite accidents.
- b) **Do not operate power tools in explosive atmospheres, such as in the presence of flammable liquids, gases or dust.** Power tools create sparks which may ignite the dust or fumes.
- c) **Keep children and bystanders away while operating a power tool.** Distractions can cause you to lose control.

2) ELECTRICAL SAFETY

- a) **Power tool plugs must match the outlet. Never modify the plug in any way. Do not use any adapter plugs with earthed (grounded) power tools.** Unmodified plugs and matching outlets will reduce risk of electric shock.
- b) **Avoid body contact with earthed or grounded surfaces such as pipes, radiators, ranges and refrigerators.** There is an increased risk of electric shock if your body is earthed or grounded.
- c) **Do not expose power tools to rain or wet conditions.** Water entering a power tool will increase the risk of electric shock.

- d) **Do not abuse the cord. Never use the cord for carrying, pulling or unplugging the power tool. Keep cord away from heat, oil, sharp edges or moving parts.** Damaged or entangled cords increase the risk of electric shock.
 - e) **When operating a power tool outdoors, use an extension cord suitable for outdoor use.** Use of a cord suitable for outdoor use reduces the risk of electric shock.
 - f) **If operating a power tool in a damp location is unavoidable, use an earth leakage circuit breaker.** Use of an earth leakage circuit breaker reduces the risk of electric shock.
- #### 3) PERSONAL SAFETY
- a) **Stay alert, watch what you are doing and use common sense when operating a power tool. Do not use a power tool while you are tired or under the influence of drugs, alcohol or medication.** A moment of inattention while operating power tools may result in serious personal injury.
 - b) **Use personal protective equipment. Always wear eye protection.** Protective equipment such as dust mask, non-skid safety shoes, hard hat, or hearing protection used for appropriate conditions will reduce personal injuries.
 - c) **Prevent unintentional starting. Ensure the switch is in the off-position before connecting to power source and/or battery pack, picking up or carrying the tool.** Carrying power tools with your finger on the switch or energising power tools that have the switch on invites accidents.
 - d) **Remove any adjusting key or wrench before turning the power tool on.** A wrench or a key left attached to a rotating part of the power tool may result in personal injury.
 - e) **Do not overreach. Keep proper footing and balance at all times.** This enables better control of the power tool in unexpected situations.
 - f) **Dress properly. Do not wear loose clothing or jewellery. Keep your hair, clothing and gloves away from moving parts.** Loose clothes, jewellery or long hair can be caught in moving parts.
 - g) **If devices are provided for the connection of dust extraction and collection facilities, ensure these are connected and properly used.** Use of dust collection can reduce dust-related hazards.
- #### 4) POWER TOOL USE AND CARE
- a) **Do not force the power tool. Use the correct power tool for your application.** The correct power tool will do the job better and safer at the rate for which it was designed.
 - b) **Do not use the power tool if the switch does not turn it on and off.** Any power tool that cannot be controlled with the switch is dangerous and must be repaired.
 - c) **Disconnect the plug from the power source and/or the battery pack from the power tool before making any adjustments, changing accessories, or storing power tools.** Such preventive safety measures reduce the risk of starting the power tool accidentally.

- d) **Store idle power tools out of the reach of children and do not allow persons unfamiliar with the power tool or these instructions to operate the power tool.**

Power tools are dangerous in the hands of untrained users.

- e) **Maintain power tools. Check for misalignment or binding of moving parts, breakage of parts and any other condition that may affect the power tool's operation. If damaged, have the power tool repaired before use.** Many accidents are caused by poorly maintained power tools.

- f) **Keep cutting tools sharp and clean.**

Properly maintained cutting tools with sharp cutting edges are less likely to bind and are easier to control.

- g) **Use the power tool, accessories and tool bits etc., in accordance with these instructions, taking into account the working conditions and the work to be performed.** Use of the power tool for operations different from those intended could result in a hazardous situation.

5) SERVICE

- a) **Have your power tool serviced by a qualified repair person using only identical replacement parts.**

This will ensure that the safety of the power tool is maintained.

SAFETY INSTRUCTIONS FOR IMPACT DRILLS

- **Wear ear protectors with impact drills** (exposure to noise can cause hearing loss)
- **Use auxiliary handles supplied with the tool** (loss of control can cause personal injury)
- **Hold the power tool only by the insulated gripping surfaces when performing an operation where the accessory may contact hidden wiring or its own power cord** (contact with a "live" wire will also make exposed metal parts of the power tool "live" and shock the operator); **always use auxiliary handle F ②**
- **Use suitable detectors to find hidden utility lines or call the local utility company for assistance** (contact with electric lines can lead to fire or electrical shock; damaging a gas line can result in an explosion; penetrating a water pipe will cause property damage or an electrical shock)
- Avoid damage that can be caused by screws, nails and other elements in your workpiece; remove them before you start working
- Always keep the cord away from moving parts of the tool
- **Secure the workpiece** (a workpiece clamped with clamping devices or in a vice is held more securely than by hand)
- When you put away the tool, switch off the motor and ensure that all moving parts have come to a complete standstill
- Use completely unrolled and safe extension cords with a capacity of 13 Amps
- In case of electrical or mechanical malfunction, immediately switch off the tool and disconnect the plug
- SKIL can assure flawless functioning of the tool only when the correct accessories are used which can be obtained from your SKIL dealer

- Use only accessories with an allowable speed matching at least the highest no-load speed of the tool
- This tool should not be used by people under the age of 16 years

- **Do not work materials containing asbestos** (asbestos is considered carcinogenic)

- Dust from material such as paint containing lead, some wood species, minerals and metal may be harmful (contact with or inhalation of the dust may cause allergic reactions and/or respiratory diseases to the operator or bystanders); **wear a dust mask ④ and work with a dust extraction device when connectable**

- Certain kinds of dust are classified as carcinogenic (such as oak and beech dust) especially in conjunction with additives for wood conditioning; **wear a dust mask ④ and work with a dust extraction device when connectable**

- Follow the dust-related national requirements for the materials you want to work with

- If the cord is damaged or cut through while working, do not touch the cord, but immediately disconnect the plug
- Never use the tool when cord is damaged; have it replaced by a qualified person
- Always check that the supply voltage is the same as the voltage indicated on the nameplate of the tool (tools with a rating of 230V or 240V can also be connected to a 220V supply)

- If the drill bit becomes unexpectedly jammed (causing a sudden, dangerous reaction), immediately switch off the tool

- Be aware of the forces that occur as a result of jamming (especially when drilling metals); **always use auxiliary handle F ②** and take a secure stance

- **Always disconnect plug from power source before making any adjustment or changing any accessory** WHEN CONNECTING NEW 3-PIN PLUG (not included) ⑤:

- Do not connect the blue (= neutral) or brown (= live) wire in the cord of this tool to the earth terminal of the plug
- If for any reason the old plug is cut off the cord of this tool, it must be disposed of safely and not left unattended

USE

- On/off ⑥
- Switch locking for continuous use ⑦
- Speed control for smooth starting ⑧
- Maximum speed control ⑨

With wheel C the maximum speed can be adjusted from low to high

- switch on the tool
 - lock the switch
 - turn wheel C to select maximum speed
- Changing direction of rotation ⑩
 - when not properly set in left/right position, switch A ② cannot be activated

! change direction of rotation only when tool is at a complete standstill

- Normal drilling/screwdriving versus impact drilling ⑪
! **select drilling function only when tool is switched off and plug is disconnected**
- Changing bits ⑫
 - insert the bit as deep as possible in the chuck
 - ! **do not use bits with a damaged shank**
 - ! **only use sharp bits**
- Adjusting drilling depth ⑬
- Holding and guiding the tool ⑭
! **while working, always hold the tool at the grey-coloured grip area(s)**
 - **always use auxiliary handle F ②** (can be adjusted as illustrated)
 - keep the ventilation slots uncovered
 - do not apply too much pressure on the tool; let the tool do the work for you

APPLICATION ADVICE

- For drilling in concrete or stone a steady pressure on the drill is required
- When drilling ferrous metals
 - pre-drill a smaller hole, when a large hole is required
 - lubricate drill bit occasionally with oil
- When turning in a screw at/near the cross cut end or an edge of wood, pre-drill a hole in order to avoid cracking of the wood

MAINTENANCE / SERVICE

- Always keep tool and cord clean (especially the ventilation slots)
! **disconnect the plug before cleaning**
- If the tool should fail despite the care taken in manufacturing and testing procedures, repair should be carried out by an after-sales service centre for SKIL power tools
 - send the tool **undismantled** together with proof of purchase to your dealer or the nearest SKIL service station (addresses as well as the service diagram of the tool are listed on www.skilmasters.com)

ENVIRONMENT

- **Do not dispose of electric tools, accessories and packaging together with household waste material** (only for EU countries)
 - in observance of European Directive 2002/96/EC on waste of electric and electronic equipment and its implementation in accordance with national law, electric tools that have reached the end of their life must be collected separately and returned to an environmentally compatible recycling facility
 - symbol ⑮ will remind you of this when the need for disposing occurs

CE DECLARATION OF CONFORMITY

- We declare under our sole responsibility that this product is in conformity with the following standards or standardized documents: EN 60 745, EN 55 014, in accordance with the provisions of the directives 2006/95/EC, 2004/108/EC, 98/37/EC (until Dec. 28, 2009), 2006/42/EC (from Dec. 29, 2009 on)
- **Technical file at:** SKIL Europe BV (PT-SEU/PJE), 4825 BD Breda, NL



09 SKIL Europe BV A. v.d. Kloot

NOISE/VIBRATION

- Measured in accordance with EN 60 745 the sound pressure level of this tool is 96 dB(A) and the sound power level 107 dB(A) (standard deviation: 3 dB), and the vibration * (hand-arm method; uncertainty K = 1.5 m/s²)
 - * when drilling in metal 5.9 m/s²
 - * when impact drilling in concrete 13.7 m/s²
- The vibration emission level has been measured in accordance with a standardised test given in EN 60 745; it may be used to compare one tool with another and as a preliminary assessment of exposure to vibration when using the tool for the applications mentioned
 - using the tool for different applications, or with different or poorly maintained accessories, may significantly **increase** the exposure level
 - the times when the tool is switched off or when it is running but not actually doing the job, may significantly **reduce** the exposure level
- ! **protect yourself against the effects of vibration by maintaining the tool and its accessories, keeping your hands warm, and organizing your work patterns**

